

Cooling and heating systems

1.2 Cooling ceiling system description



DS 4076 e 10-2001

1.2 Cooling ceiling systems description

Preliminary remarks

Cooling ceilings are room cooling systems for placement in the ceiling zone. Their cooling surfaces are connected with closed circuit heat conducting pipework containing flowing chilled water.

Sensitive room heat is removed via cooling ceilings. To remove latent heat or to maintain the air humidity needed for comfort and to supply a minimum outside air flow for the occupants, cooling ceilings are combined with mechanical ventilation plants.

The main advantages of cooling ceilings in comparison with air-only systems are:

- Higher thermal comfort due to
 - Draught-free indoor air flow,
 - Even temperature gradient,
 - Low noise level,
- Low operating costs,
- Low space requirements for installation.

Cooling ceilings are used in commercial applications of all kinds and in laboratories and business or industrial rooms with a high percentage of sensitive heat and low levels of pollution.

Their installation height is variable and there are almost no upwards limits. Very positive experience has been gained with installation heights of 2.5 m to 8 m. Cooling ceilings can also be positioned at even greater heights.

Types

Heat transfer between room and cooling ceiling is effected via radiation and convection. Depending on the ratio, there are two main groups of cooling ceilings:

Radiation ceilings and convection ceilings (**Figure 1**).

In radiation ceilings heat transfer by radiation predominates. It makes up about 60% of total heat exchange; 40% is via convection.

Radiation ceilings have a closed surface. They can be constructed as metal, plasterboard or plaster ceilings with inserted single cooling elements – in the form of water pipes with heat contact profiles.

If instead of being inserted in closed ceilings, the single cooling elements are surrounded by indoor air on all sides heat exchange by convection is higher. Such ceiling systems are called convection ceilings. 50% of heat transfer is effected through convection. To obtain a large heat transfer surface area, bars or ribs are stuck onto the cooling elements at different angles depending on type. The convective share is raised to about 60% - 70%.

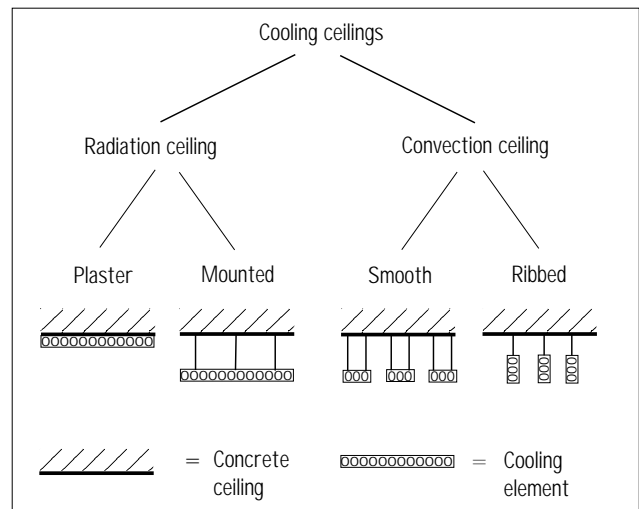

Figure 1: Main cooling ceiling groups and constructions

A special type of convection ceiling are chilled beams with an extremely dense arrangement of cooling bars, approximately 3 - 6 mm bar spacing. Here the convective share of heat exchange amounts to 90% - 95%.

When specifying the layout of radiation cooling ceilings, the influence of the selected ceiling tiles on cooling capacity must be taken into account. The radiation of the cooling ceiling is influenced by the emissivity of the tile surface. Attention must also be paid to good heat transfer from the water-bearing pipes and contact profiles to the cooling ceiling area and proper attachment of the acoustic mat.

Generally, a false ceiling can be suspended under convective cooling elements. This should have at least a 20% open area so as not to impair cooling capacity unduly.

As a rule, cooling ceilings are large-surface installations covering the whole room area (**Figure 2a** and **2b**). Exceptions are chilled beams (**Figure 2c**), which are positioned as compact units over individual zones in the room. Another possibility is to suspend large-surface cooling elements from the ceiling in parts of the room (as a rule above the workplace). This type is called a chilled sail (**Figure 2d**).

KRANTZ KOMPONENTEN can provide all the above types:

- Chilled sail
 - (customized solution): KKS, SKS and DK type
 - with built-in fresh air supply - active DK
 - without built-in fresh air supply - passive DK

While the first three types are more or less standardized, the chilled sail can be individually designed to meet architectural requirements.

1.2 Cooling ceiling systems description

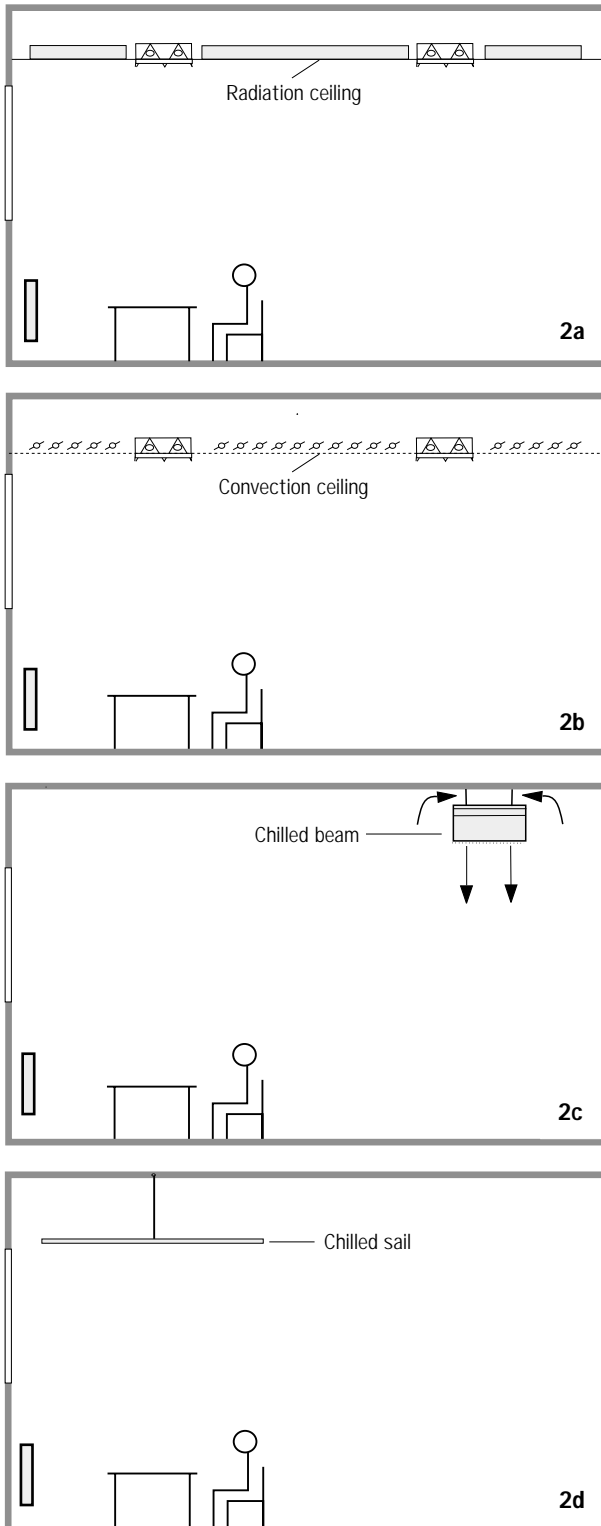

Figure 2: Placement of different cooling ceilings
2a: Large-surface cooling ceiling as radiation ceiling
2b: Large-surface cooling ceiling as convection ceiling
2c: Chilled beam
2d: Chilled sail

Combination with mechanical ventilation

As already mentioned, cooling ceilings can only remove sensitive, but not latent heat, which is largely a result of humidity emitted by people. When using cooling ceilings, the supply of minimum outside air for the occupants must also be secured.

This is why cooling ceilings must be combined with ventilation plants. The task of ventilation plants is to increase air quality in the room, i.e. supply the minimum outside air flow rate and keep indoor air humidity in the comfort range by air exchange in the room.

The minimum outside air flow rate corresponds in offices to an air volume flow rate of about 1.7 to $2.2 \text{ l/(s} \cdot \text{m}^2)$ (6 to $8 \text{ m}^3/\text{h} \cdot \text{m}^2$) - as is usual practice in Germany. This is only a fraction of the air volume flow rate required by conventional HVAC plant to cover the room cooling load.

In general, cooling ceilings can be combined with all available air distribution systems. As in **Figure 3**, air distribution systems can be classified into two main groups:

- Air distribution systems to generate a turbulent mixing-air flow (mixing air flow ventilation).
- Air distribution systems to generate a turbulent stratified air flow (displacement ventilation).

Turbulent mixing-air is produced by air outlets that generate high-induction air jets at high discharge momentum. Due to the intensive admixture of indoor air with the supply air jets, the material and thermal loads are distributed evenly in the room. This group includes ceiling and wall air outlets with high discharge momentum (e.g. ceiling twist, slot or whirl outlets).

When cool air is discharged in the floor zone, a stratified flow can be generated. Due to the buoyancy in the room, the warm air rises. It is collected in the ceiling zone. More or less pronounced layers form with various temperatures and with material concentrations over the room height. When a combination with cooling ceilings is used, the stratification is, however, neutralized, because part of the indoor air flow that cools down again at the cooling ceiling flows back into the occupied zone. This results in a broad equalization of temperatures and material concentrations in the room. The air outlets used here are those with air supply in the floor zone, e.g. floor twist or displacement outlets. Displacement outlets for placement under the ceiling can also be used, where after a slight admixture with indoor air, the supply air flows downwards along the wall for example and glides over the floor before it escapes upward due to buoyancy.

1.2 Cooling ceiling systems description

Turbulent mixing air flow

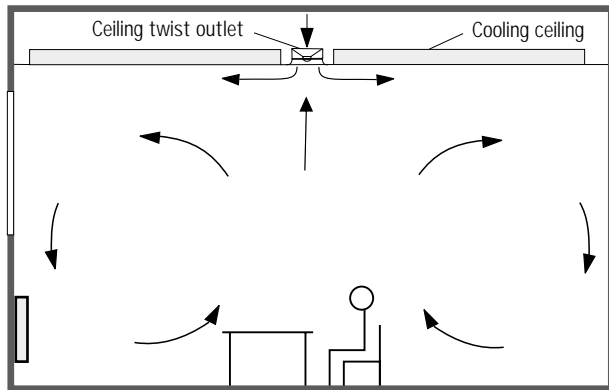

Stratified flow

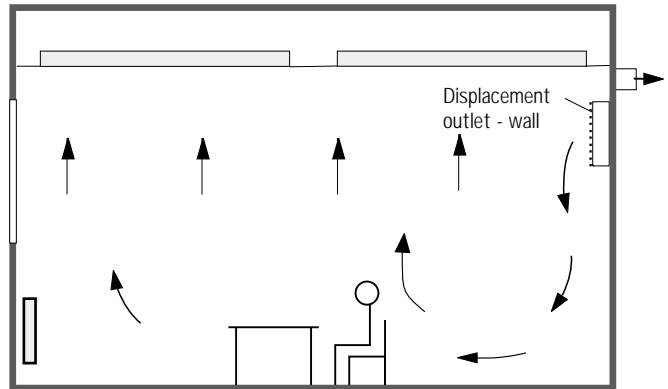
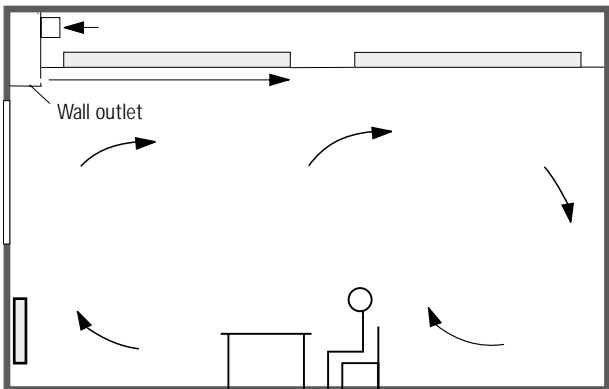
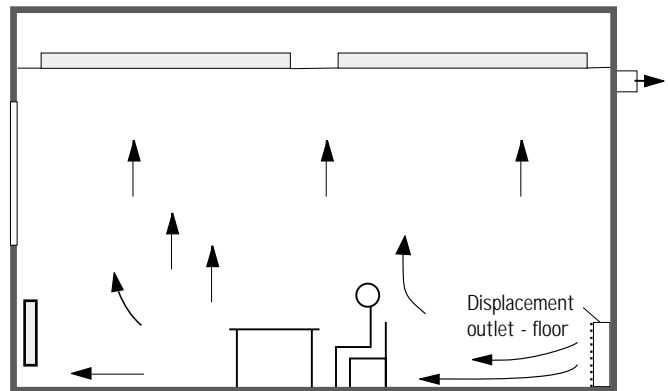
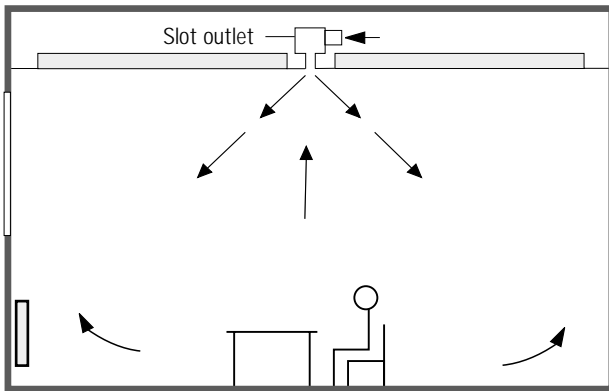
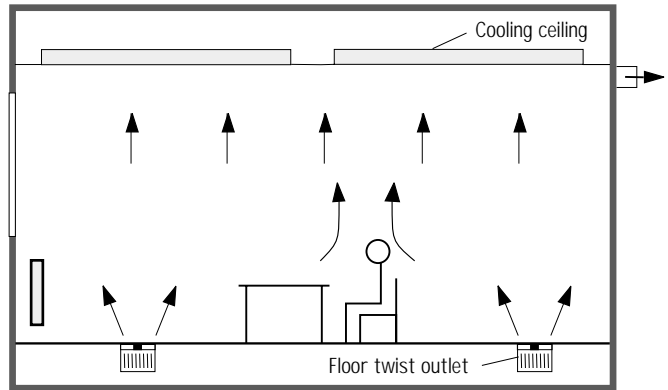

Figure 3: Combination of cooling ceilings with different air distribution systems

Mechanical ventilation removes latent heat and supplies fresh air, but it also provides additional cooling capacity.

When displacement outlets are fitted in the floor zone, the temperature difference between supply air and indoor air should not exceed -3 K to avoid subtemperatures in the floor zone. As there is no thermal stratification over room height, return air temperature is approximately the same as indoor air temperature in the occupied zone. Additional cooling capacity of displacement ventilation thus amounts to a maximum of $6 - 8\text{ W/m}^2$. If supply air is discharged from displacement outlets below the ceiling, the max. temperature difference between supply air and indoor air can amount to -6 K . This results in an air-side cooling capacity of $12 - 16\text{ W/m}^2$.

If floor twist outlets are used, the minimum supply air temperature amounts to 18°C . For a room temperature of 26°C , for example, the additional cooling capacity comes to $16 - 22\text{ W/m}^2$.

When ceiling air outlets with turbulent mixing air flow are used, the maximum temperature difference between supply air and indoor air can range between -8 and -10 K . So an additional cooling load of 16 to 27 W/m^2 can be removed.

This air-side cooling capacity is added to the cooling ceiling capacity.

1.2 Cooling ceiling systems description

The supply air in the air handling unit always has to be filtered and dehumidified. In dehumidification it is cooled to below the dewpoint of indoor air. In combination with cooling ceilings the dewpoint temperature of the supply air should be 1-2 K below the flow temperature of the cooling ceiling system. The maximum dewpoint temperature of indoor air amounts to 16°C. According to the comfort field in **Figures 4** and **5** this corresponds to a maximum absolute indoor air moisture content of 11.5 g/kg of dry air.

When using **ceiling air outlets** the supply air can be discharged into the room directly after dehumidification. Accounting for an additional temperature increase in the fan and the air pipes of at least 1 K, the supply air has a temperature of 14 - 17°C on exiting the air outlet. These are permissible supply air temperatures for ceiling air outlets in turbulent mixing air flow. If required, the supply air can be reheated a little.

Where **displacement outlets** in the floor zone are used, the supply air must always be heated up after dehumidification. Supply air should be 1 - 3 K colder than indoor air. This means that at a room temperature of 22°C the supply air temperature must range between 19 and 21°C and at a room temperature of 26°C, between 23 and 25°C. When displacement outlets are placed in ceiling proximity, supply air temperature can be up to about 6 K lower than room temperature. With displacement ventilation care must always be taken to ensure that the supply air temperature does not exceed room temperature, because the fresh supply air cannot then penetrate deep enough into the room.

When **floor twist outlets** are used for fresh air supply, the supply air is heated to at least 18°C after dehumidification before it enters the room. The supply air jets are insensitive to possible excess temperatures, i.e. a good indoor air flow is assured even at supply air temperatures above room temperature.

The changes in air conditions are shown in the graphs in **Figure 4** and **5**.

Cooling ceilings and window ventilation

Sometimes for example, combined mechanical ventilation plants are not installed for reasons of cost. The necessary fresh air supply is then provided via window ventilation, i.e. by opening windows. Controlled air supply and effective dehumidification of indoor air is not possible this way. In addition to this, window ventilation has other disadvantages:

- Higher room cooling load on warm summer days,
- Higher heat consumption on cold days,
- Entry of unfiltered outside air into the rooms,
- Road noise more audible in the room,
- Heat recovery is not possible,
- Greater danger of cooling elements falling below dewpoint on warm and humid days,
- Higher room temperatures on warm summer days,
- No assured draught avoidance.

Considering the many disadvantages of window ventilation, we recommend combining cooling ceilings with a mechanical ventilation plant.

DS 4076 e 10-2001

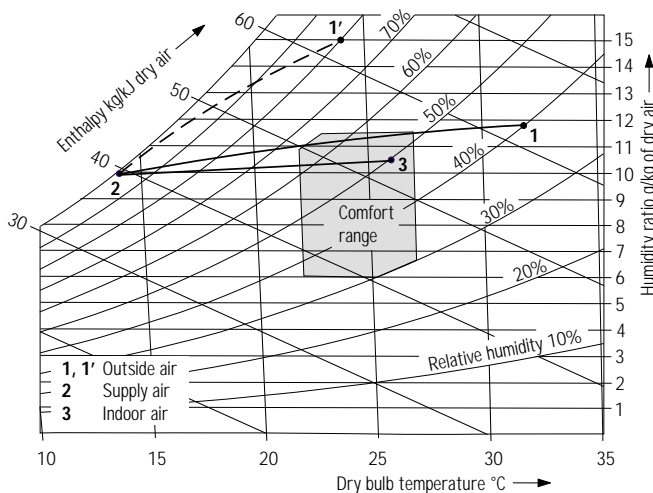

Figure 4: Changes in air conditions: cooling ceiling and ceiling air outlets (under German conditions)

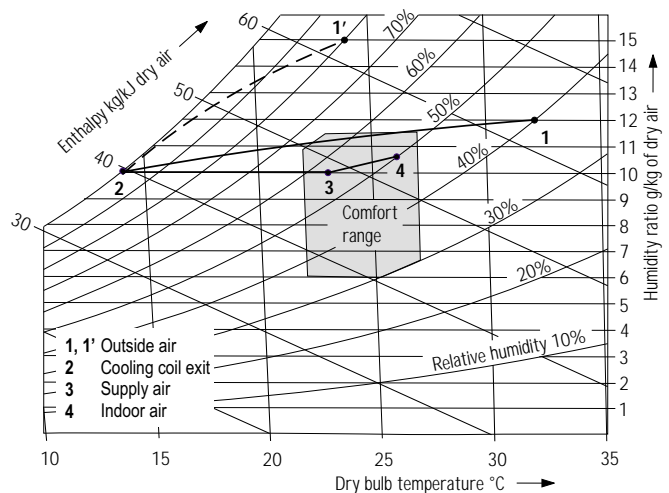

Figure 5: Changes in air conditions: cooling ceiling and displacement outlets (under German conditions)

1.2 Cooling ceiling systems description

Thermal comfort

With cooling ceilings and combined mechanical ventilation high thermal comfort can be obtained in the rooms:

- Low indoor air velocities, as a rule under 0.12 m/s,
- Even temperature gradient, vertical temperature differences under 1 K,
- Operating room temperature 0.5 - 1 K lower than air-only systems, i.e. higher cooling effect compared with conventional air-conditioning systems,
- Lower sound pressure level, because the air volume flow rate is comparatively small.

Figure 6 shows for example the timeline of indoor air velocities at 1.3 m room height and a specific cooling capacity of a convective cooling ceiling system of 115 W/m² per cooling element. The mean rate of indoor air velocities is under 0.10 m/s. There are no significant differences in the degree of turbulence of air flow for the different air distribution systems.

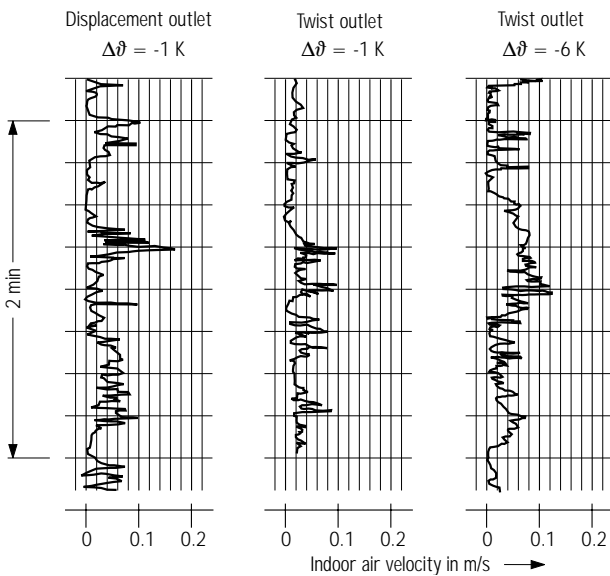

Figure 6: Indoor air velocities; cooling ceiling with various air distribution systems

Figures 7 and **8** show the vertical temperature gradient. In both the combination with displacement air outlets and with ceiling twist outlets, the vertical thermal stratification is extremely low. From the floor zone to the ceiling, it amounts to less than 1 K. A vertical temperature gradient of 2 K/m is permitted by DIN 1946, Part 2.

The horizontal temperature differences amount to a tenth of a degree only and are therefore very low as well.

The surface temperature of the cooling ceilings is usually 4 to 8 K under indoor air temperature. This makes for greater comfort for occupants, because the operating room temperature is reduced by about 0.5 to 1 K as compared with air-only systems. The subjective cooling effect is thus increased.

Due to the absence of thermal stratification in the room, the ventilation efficiency is independent of the combined air distribution system. The numerical value for ventilation efficiency is about 1. This means that approximately the same air quality prevails in the whole room – from the floor to the ceiling. There are no differences between turbulent mixing air flow and stratified flow.

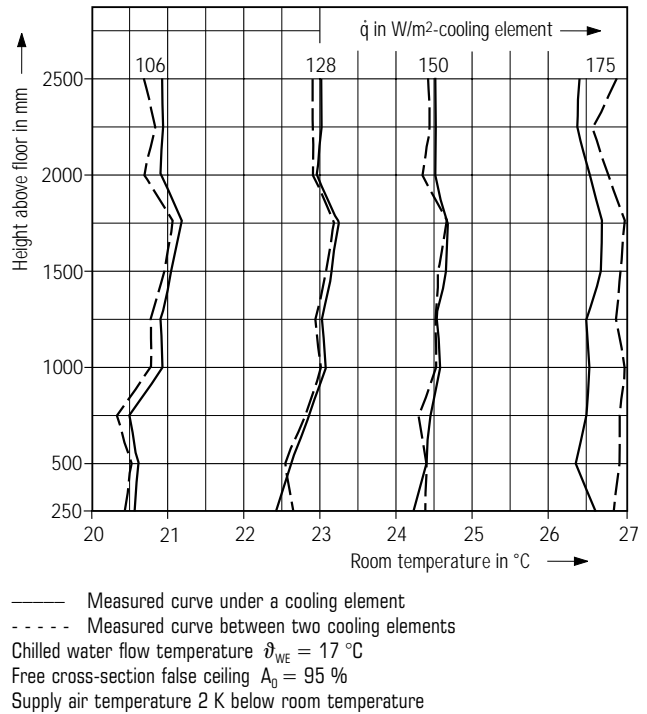

Figure 7: Vertical temperature gradient; cooling ceiling (SKS system) and displacement ventilation

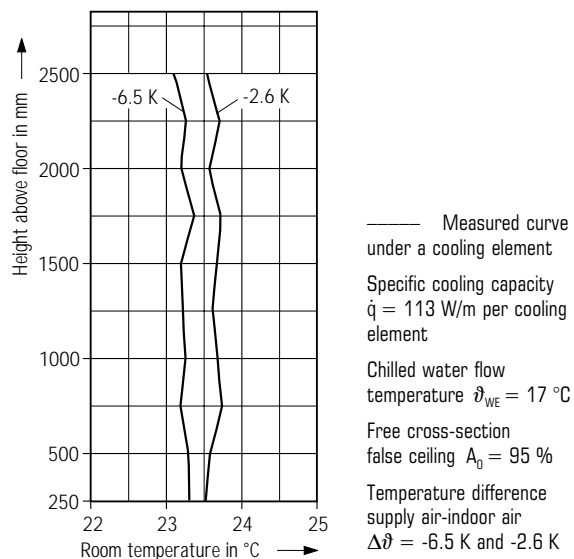

Figure 8: Vertical temperature gradient; cooling ceiling (SKS system) and ceiling twist outlets

1.2 Cooling and ceiling systems description

Water temperatures and cooling capacities

As already mentioned, the maximum dewpoint temperature of indoor air in air-conditioned rooms is mostly up to 16°C. To prevent the danger of the temperature falling below dewpoint at the chilled water pipes or cooling surfaces, the water flow temperature should not be below 16°C. The flow temperature should be 1 - 2 K higher than dewpoint temperature. As a rule, the return water temperature is set 2 K above flow temperature.

Apart from the construction form and the cooling ceiling integration the possible cooling capacity depends largely on the temperature difference between the room and the chilled water. Maximum room temperature is normally set at 24 to 26°C (in Germany as a rule at 26°C). The difference between room temperature and mean water temperature therefore ranges in the layout case between 7 and 9 K. The following cooling capacities are therefore possible:

- Radiation ceilings:

$\Delta\vartheta_{RW} = 9\text{ K}$	\Rightarrow	60 - 85 W/m ²
$\Delta\vartheta_{RW} = 7\text{ K}$	\Rightarrow	45 - 65 W/m ²

- Convection ceilings:

$\Delta\vartheta_{RW} = 9\text{ K}$	\Rightarrow	bis 180 W/m ²
$\Delta\vartheta_{RW} = 7\text{ K}$	\Rightarrow	bis 130 W/m ²

The capacity data relate to the projected cooling ceiling area.

Details are available in the technical layout brochure for the respective cooling ceiling type from KRANTZ KOMPONENTEN.

To maintain the very high thermal comfort (air velocities well under the limit values to DIN 1946, Part 2), we recommend limiting the specific cooling capacity with convection ceilings to 160 W/m².

To calculate the room cooling load removed the air-side cooling capacity must always be added.

Control

Room temperature is controlled by the cooling capacity of the cooling ceiling. The ventilation plant provides the minimum outside air supply and maintains indoor air humidity.

Cooling ceiling capacity or room temperature can be controlled in the following ways (**Figure 9**):

- Altering chilled water flow through
 - stop valves with servomotor,
 - cross valves with servomotor.

- Altering the chilled water flow temperature with stop valve, servomotor and separate water pump.

Plant control also includes dewpoint monitoring (see page 8).

Due to the complexity involved, it is best to have a joint control design for cooling ceiling, mechanical ventilation and heating.

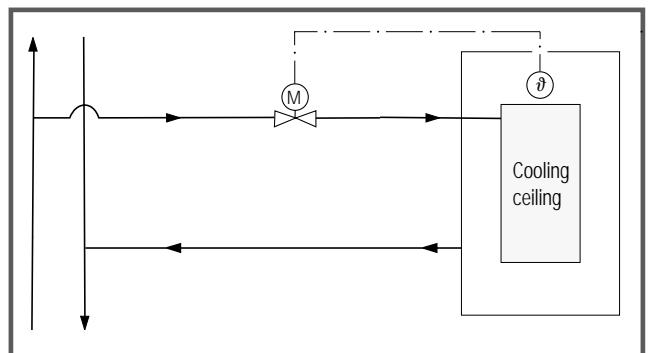

Alteration of chilled water flow rate with stop valve and servomotor

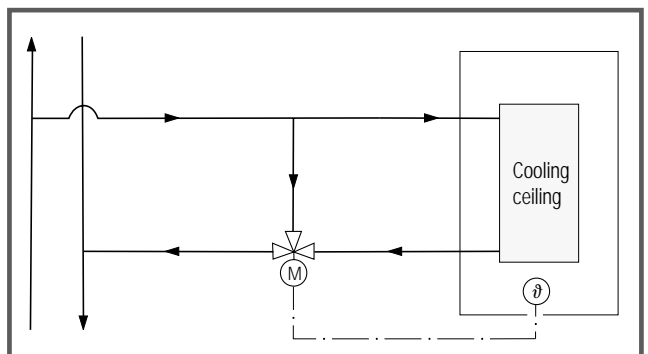

Alteration of chilled water flow rate with cross valve and servomotor

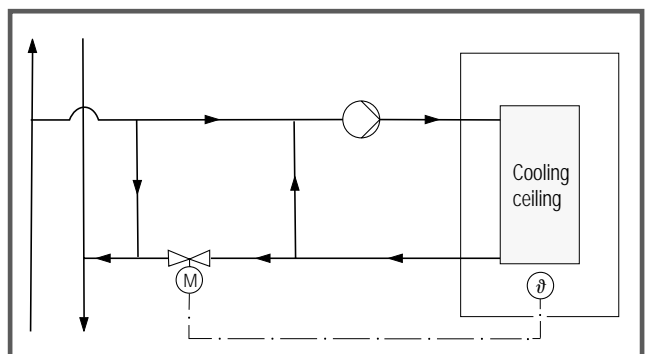

Alteration of chilled water flow temperature with stop valve, servomotor and separate water pump

Figure 9: Control of room temperature in response to cooling ceiling capacity by altering chilled water flow rate or chilled water flow temperature

1.2 Cooling ceiling systems description

Preventing a temperature drop below dewpoint

The dewpoint temperature of the indoor air must always be lower than the surface temperature of the cooling ceiling installation. This is a reliable way to avoid condensation. For greater reliability, we recommend using dewpoint detectors. These are fitted at the coldest point on the flow pipe of the cooling ceiling installation. These signal the start of local condensation at an early stage and trigger an increase in supply water temperature or a chilled water supply shutoff, for example.

If the building has openable windows, care must be taken to ensure that the dewpoint temperature of the outside air can stay above 16°C under certain weather conditions. In Germany the annual cumulative frequency of the outside dewpoint temperature amounts to:

≥ 16 °C:	⇒	2 - 4 %
≥ 17 °C:	⇒	1 - 2 %.

To prevent condensation at chilled water pipes with openable windows and the sporadic occurrence of high dewpoint temperatures of the outside air, the following precautions must be taken:

- Window contact signal, which can turn off the water flow in the control system when the window is opened or raise supply temperature to at least 18°C,
- Dewpoint monitoring with sensors at the water flow pipe (at the coldest point), through which either the chilled water flow can be shut off or the flow temperature raised to at least 18°C when dewpoint is exceeded – if the window contact is damaged,
- If no contact signals are possible at openable windows, the supply water temperature must be generally raised at a high outside air dewpoint.

Heating with a cooling ceiling

With cooling ceilings the room can be heated during the cold season, if the following conditions are met:

- Heating requirements are met, i.e. the desired room temperature can be maintained.
- The radiation temperature asymmetry of the surrounding surfaces is kept within the comfort range. DIN 1946, Part 2 specifies that radiation temperature asymmetry in the room may not exceed 3.5 K to prevent a one-sided warming or cooling of occupants due to unequal temperatures of the walled-in surfaces.

- The vertical temperature gradient in the room does not exceed the permissible maximum of 2 K/m.
- The cold air drop at the window facade is kept within limits to ensure that the indoor air flow remains draught-free.

These requirements can generally be met under the following conditions:

- Maximum heat consumption of 40 - 50 W/m², related to floor area
- Heat transmission coefficient of window:
 $k \leq 1.3 \text{ W}/(\text{m}^2 \cdot \text{K})$ for 3 m high windows
 $k \leq 1.8 \text{ W}/(\text{m}^2 \cdot \text{K})$ for 1.5 m high windows

It is better to design the heating surface only as an approx. 1 m wide strip flush with the window facade than use the whole ceiling for heating. This reduces the asymmetry of the radiation temperatures.

Chilled beams are (without outdoor air) not suitable for heating, because 90% of heat transfer takes place via convection. The resultant thermal stratification in the room would be too large.

With suitable installation/suitable construction and maximum primary air flows, active chilled beams (with outdoor air) can be used for heating - up to approx. 50 W/m² room area while retaining thermal comfort.

When heating with cooling ceilings the water flow temperature as a rule is ≤ 40°C; the return temperature is 2 - 4 K below the flow temperature.

Space requirements

There are two systems to accommodate, the cooling ceiling system and the mechanical ventilation plant. The ventilation plant is small with a simple construction as it is only scaled to condition and supply the minimum outside air portion. It takes up little space in the central station. Space is also saved due to smaller duct shafts and smaller heights above the false ceilings. Altogether less space is required to accommodate both systems than for a conventional air-conditioning system with the same cooling capacity.

Space savings range between about 35% to 45% in the rising/fall shafts and false ceilings and 40% to 60% in the central stations.

1.2 Cooling ceiling systems description

Investment and energy costs

The higher the specific room cooling load, the more economical are the investment costs for cooling ceiling systems, incl. mechanical ventilation, as compared with conventional air-conditioning systems. The energy costs are always lower.

Figure 10 shows an example of the cost ratio between a cooling ceiling system (as in **Figure 11**) and a conventional variable air volume system (VAV).

Leaving aside the costs for space requirements, for specific indoor cooling loads of approximately $> 55 \text{ W/m}^2$ the investment costs of the cooling ceiling system including mechanical ventilation are lower than for the VAV system. The reasons are the low cost for ventilation plant (lower air volume flow rate, less sophisticated plant) and the lower cooling capacity, which means smaller refrigeration machines (incl. pipework). In the VAV system a much higher dehumidification capacity is needed for the outside air intake. Also, in the cooling ceiling system the maximum cooling capacity of the cooling coil does not coincide with the maximum cooling requirements for the cooling ceiling.

If space savings are taken into account in investment costs the cooling ceiling compares even more favourably.

In the cooling ceiling system, energy costs, incl. water costs, are lower than in the VAV system. The higher the specific room cooling load, the more economical are energy costs for cooling ceiling systems as compared with conventional VAV systems. For example, if the energy costs for the cooling ceiling system are about 10% lower for a specific room cooling load of 50 W/m^2 than for the VAV system, this difference increases at 75 W/m^2 to about 20%. The main reasons for this are the low costs for air treatment and air transport.

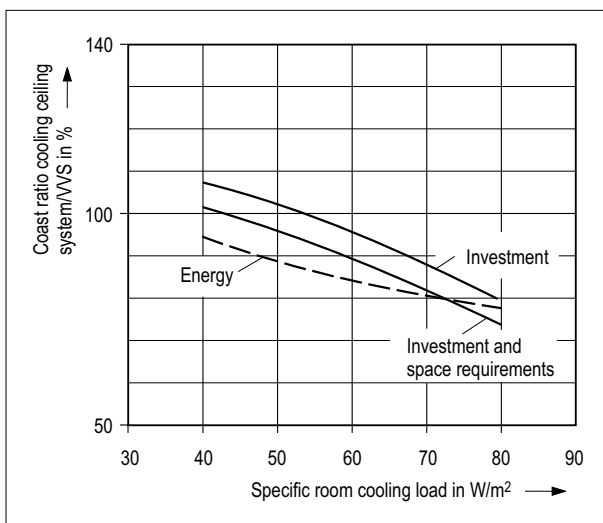

Figure 10: Cost ratio between cooling ceiling system / VAV system (example)

When comparing energy costs, it is assumed that the cooling ceiling system uses free cooling with outside air. The use of free cooling reduces the energy costs of the cooling ceiling system by 10% to 20%.

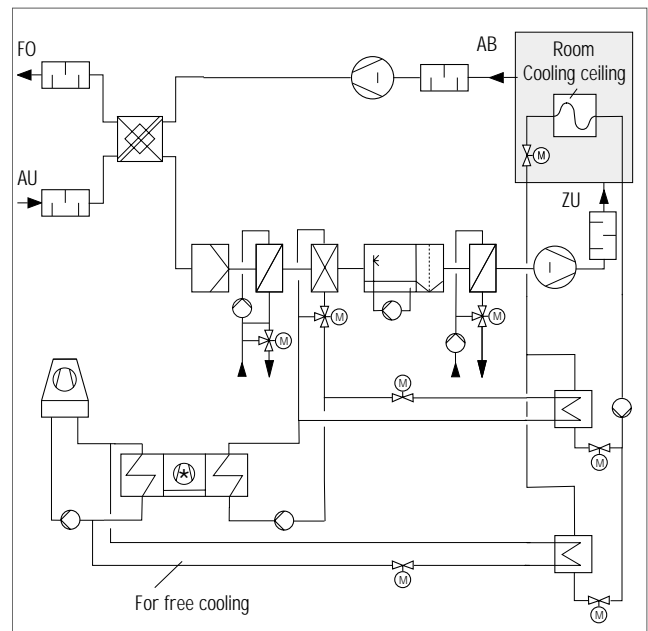

Figure 11: Principle of a cooling ceiling system + mechanical ventilation

Installation

The installation of cooling ceilings is easy and can be performed by specialist building engineering firms.

When inserting cooling elements in the tiles of the radiation ceiling, make sure of firm surface contact.

The cooling ceilings or elements are equipped with fastening points for attaching the suspension hangers. When mounting at the concrete ceiling or a strapping the relevant rules in DIN 18 186 on light ceiling facing and false ceilings must be referred to.

The standard water-side connection is usually made at the pipe terminal with customary soldered, screw or plug-in connection.

Details on cooling ceiling installation are available in technical layout brochures for the respective cooling ceiling type from KRANTZ KOMPONENTEN.

Timely scheduling of the different installations by the cooling ceiling and the false ceiling supplier is needed to avoid mutual interference in installation work.

Subject to technical alterations!

