

Please note,
type code is new,
see last page.

Technical Selection

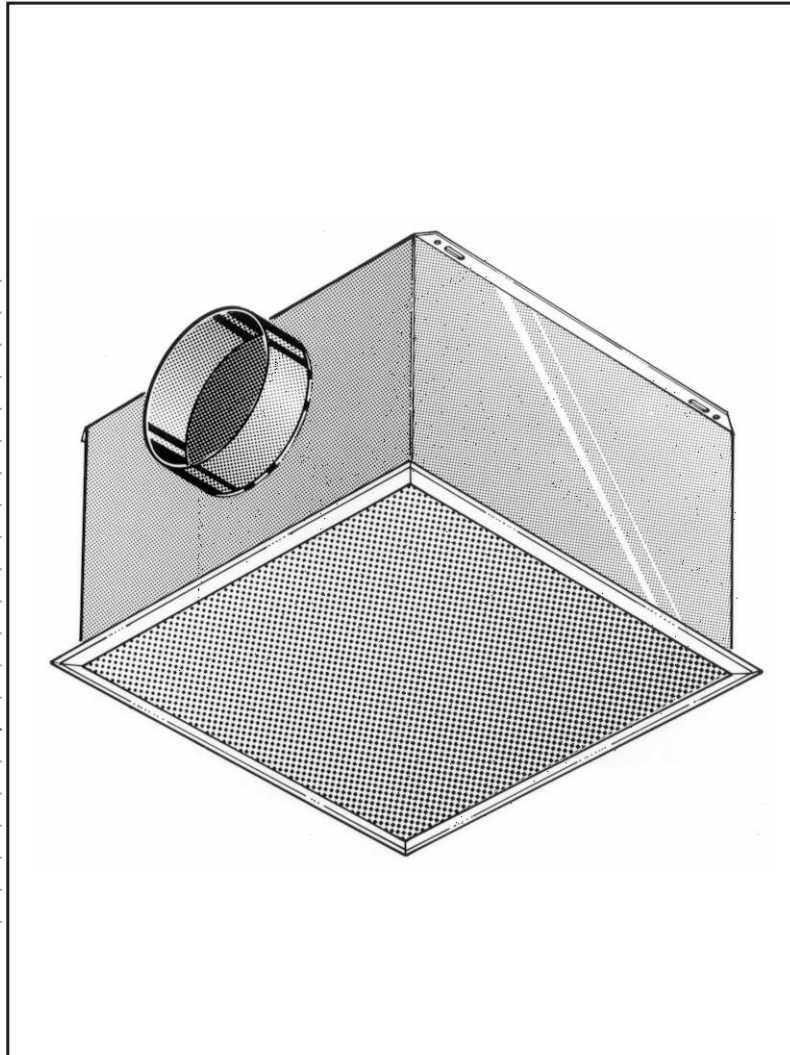

- Ceiling displacement outlet**
- non-adjustable Q-DN....
 - adjustable Q-DV....

Preliminary remarks

Ceiling displacement outlets are best used where low-turbulence supply air has to be discharged from the ceiling into the room. When cooling, the cold supply air reaches the floor zone due to gravity at usual, low air discharge velocities.

If the supply air also has a heating function, the discharge velocity must be increased so that sufficient warm air flows through the occupied zone when heating. This is what the adjustable ceiling displacement outlet is for.

Typical fields of application are department stores and showrooms where the supply air from ceiling displacement outlets is supposed to cool only or also heat. KRANTZ KOMPONENTEN supplies **non-adjustable** or **adjustable** ceiling displacement outlets to suit needs.

Construction design and function

Non-adjustable ceiling displacement outlet: **without** heating function, Type Q-DN

The ceiling displacement outlet consists essentially of the housing **1**, connection spigot **2** and the perforated, square or rectangular removable air discharge element **3**. The connection spigot can be placed at the side or above. The perforated metal sheet **4** and other implants help shape the jet pattern. It is suspended from the ceiling at fastening points **8** with a threaded rod or standard fast clamping devices.

Adjustable ceiling displacement outlet: **with** heating function, Type Q-DV

In outward appearance the adjustable ceiling displacement outlet resembles the non-adjustable ceiling displacement outlet. In the centre of the adjustable model an additional core tube **5** is installed that can be steplessly opened and closed with a valve disk **6**.

Under isothermal conditions, the core tube is already slightly open and when heating with rising temperature difference it opens progressively. The momentum of the support jet through the core tube is increased: the low-momentum air jets from the surrounding perforated discharge area are induced and the penetration depth of the whole supply air downward is lengthened. The valve disk can be adjusted manually or with an electrical servomotor **7**; automatic control in response to temperature difference between supply air and indoor air with thermostat is available on request.

Layout data

Discharge velocity		When cooling	When heating ²⁾
- max.	m/s	0.45	0.45
- min.	m/s	0.15	0.30
Volume flow rate			
- max.	l/s	140	140
- min.	l/s	45	95
- max.	m ³ /h	500	500
- min.	m ³ /h	170	340
Max. temperature difference			
- Supply air-indoor air ¹⁾	K	- 6	+ 4
- Supply air-exhaust air	K	- 8	-
Min. supply air temperatur	°C	16	
Discharge height	m	2.5 to 3.5	

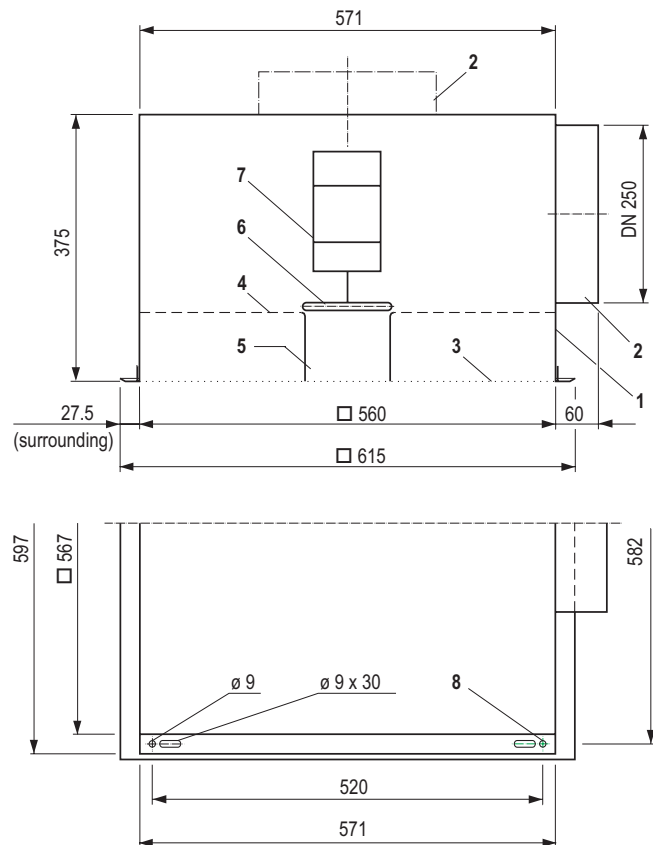

Figure 1: Adjustable ceiling displacement outlet; dimensions for ceiling raster 625 mm x 625 mm; also applies for non-adjustable model.



Figure 2: Ceiling displacement outlet

1) at 1.1 m height in occupied zone

2) only for the adjustable ceiling displacement outlet

Indoor air flow

The ceiling displacement outlet should not be placed above permanent workplaces but above adjacent room zones. Figure 3 for example shows the indoor air flow pattern for a typical placement of the air outlet above a gangway or near a corridor wall.

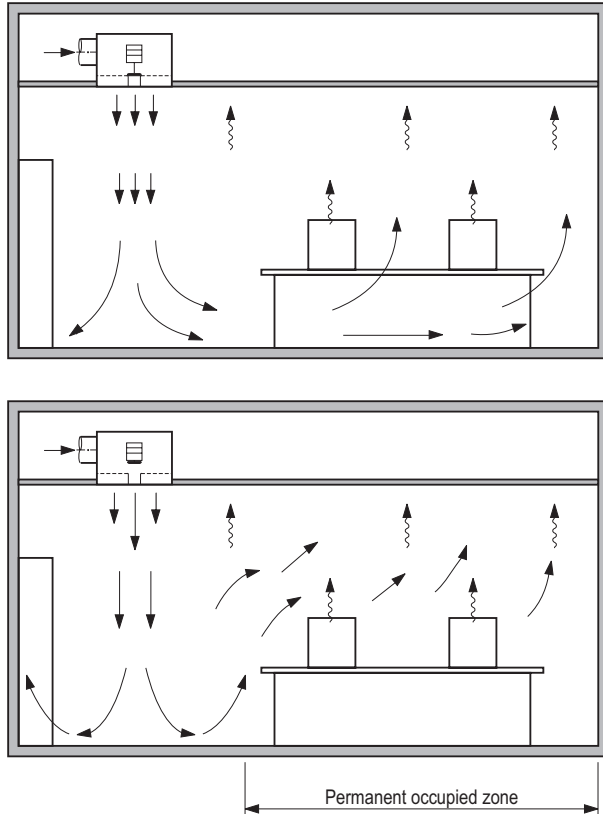

Figure 3: Indoor air pattern, shown with adjustable ceiling displacement outlet, above: when cooling, below: when heating. The flow pattern when cooling applies for the non-adjustable and adjustable outlet.

Cooling mode: non-adjustable and adjustable ceiling displacement outlet

The indoor air flow of the non-adjustable and the adjustable outlets are the same with closed core tube (when cooling). The supply air disperses over the complete floor space, ascends along the heat sources through the occupied zone and is collected in the ceiling zone.

Heating mode: adjustable ceiling displacement outlet

Under isothermal conditions and when heating the supply air reaches the floor zone after the core tube opens, disperses in a radius of approximately 1 m over the floor, rises and penetrates the room more or less horizontally at a height of about 1.5 to 2 m. It is buoyed by the heat sources and ascends slowly to the collec-

tion points of the exhaust air system. Although the supply air does not disperse widely over the floor space as in cooling, the whole room is sufficiently flushed.

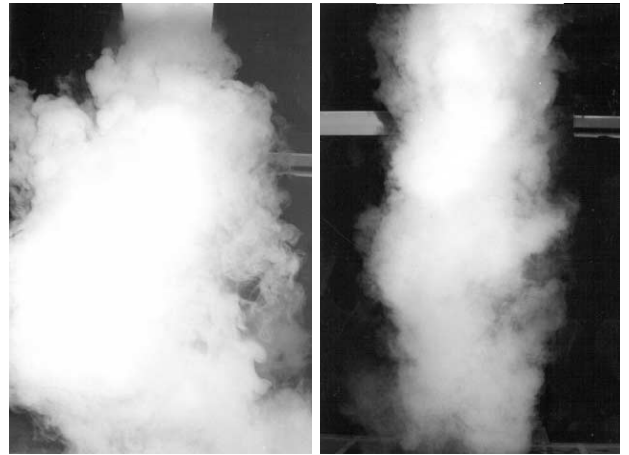

Figure 4: Jet dispersal made visible with a smoke tracer, left: cooling mode; right: heating mode.

Indoor air velocities

In the occupied zone outside the direct downward air jet, the indoor air velocities are very low. At head height of a sedentary or standing person, the air velocities are under 0.1 m/s, i.e. the indoor air flow is absolutely draught-free. The air velocities in the floor zone (0.1 m over the floor) are ≤ 0.25 m/s.

Outside the permanent occupied zone, higher air velocities occur directly under the adjustable ceiling displacement outlet. These air velocities are not disturbing for an occupant standing under the air outlet for a short time. A warm supply air jet during heating operation is usually felt as a pleasant sensation.

Room temperatures

The distribution of the air temperature is very even in the occupied zone. Measured over the length of the room, the horizontal temperature differences amount to only some tenths of a degree. As a rule, the vertical temperature difference from the floor to a height of 1.8 m reaches values of not more than 1.2 K when cooling and 1.5 K when heating. This confirms the intensive flushing of the occupied zone in all load cases.

Outside the permanent occupied zone, at a height of 1.1 m and 1.8 m under the air outlet, the air temperature when cooling is approx. 2 K lower and when heating about 1.5 K higher than in the rest of the room.

The exhaust air temperature is 1.3 to 1.5 K higher than room temperature in the occupied zone.

Sound power level and pressure loss

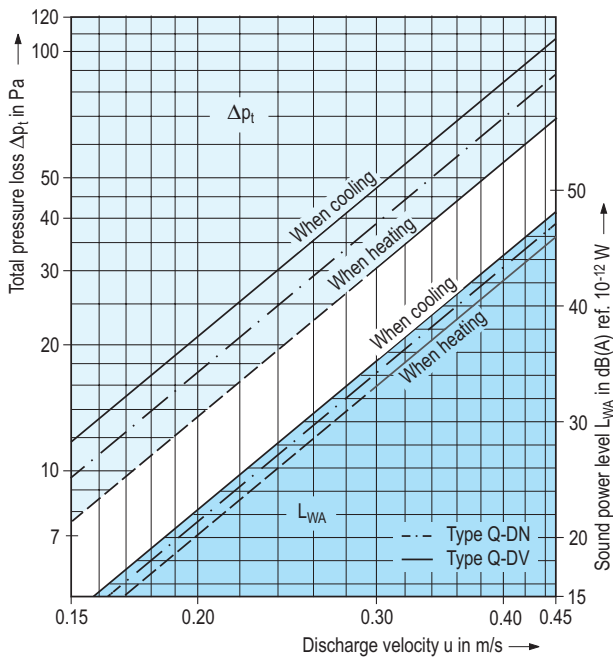

Features

- Placement in room ceilings either flush or suspended
- Low-turbulence displacement flow
- Supply air jet directed vertically downward
- Discharge height 2.5 to 3.5 m
- Adjustable air outlet also available with support jet for sufficient penetration depth with warm supply air (when heating)
- Valve disk adjustment manually or with electrical servomotor
- Temperature difference of supply air-indoor air up to - 6 K when cooling and + 4 K when heating with adjustable outlet
- Temperature difference of supply air-exhaust air up to -8 K when cooling
- Raster dimensions of 625 mm x 625 mm; other dimensions on request
- Removable air discharge element
- Made of sheet steel, painted in selected colour

1 Cross for adjustable ceiling displacement outlets

Type code

Q - D _ _ _ / _ _ _ _
 Displacement outlet
 Kind / function
 Size
 Adjustment

Please note,
type code is new,
see last page.

Kind / Function

- D = ceiling installation
- V = adjustable
- N = non-adjustable

Size

Air discharge surface in mm
560 / 560

Adjustment

- M = manual
- E = with electrical servomotor

Tender text

..... units

Ceiling displacement outlet for vertical, low-turbulence air supply and intensive flushing of occupied zone,

1 adjustable with support jet for high penetration depth also with warm supply air (heating mode), consisting of:

housing with square or rectangular perforated, removable air discharge element and circular connection spigot, lateral, above,

1 built-in core tube to generate support jet, with valve disk for support jet regulation to alter jet penetration depth, implants for an optimum jet pattern.

Technical data:

Volume flow rate: l/s
 Adm. sound power level: dB(A)
 ref. 10⁻¹² W

- valve disk adjustment
 - manual.
 - with electrical servomotor.

Material: galvanized steel

Visible air outlet element painted to: RAL

Make: KRANTZ KOMponenten

Type: Q - D _ _ _ / _ _ _ _

Subject to technical alterations!

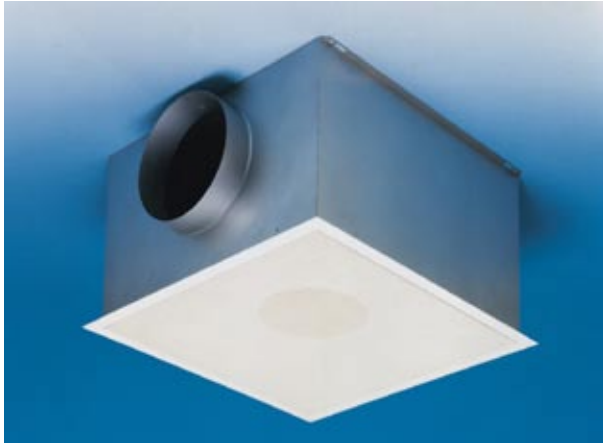

Ceiling displacement outlet

Type code

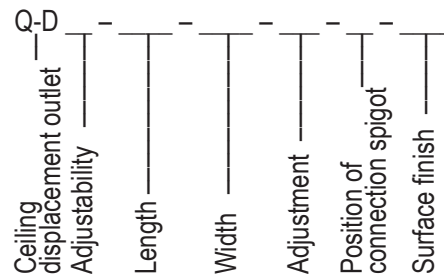

Adjustability

- N = non-adjustable
- V = adjustable

Length

- 560 = 560 mm

Width

- 560 = Width 560 mm

Adjustment

- MA = manual
- E22 = „Siemens servomotor, 0-10 V modulation“, stroke drive type GDB161.2E
- E23 = „Siemens servomotor, 3-point type, 24 V“, stroke drive type GDB131.2E
- E24 = „Siemens servomotor, 3-point type, 230 V“, stroke drive type GDB331.2E
- T2 = Thermostatic adjusting unit, 16-28 °C

Position of connection spigot

- O = Connection spigot on top
- S = Connection spigot on side

Surface finish

- 9010 = Face painted to RAL9010, semi-matt
- = Face painted to RAL

Subject to technical alteration.