

Please note,
type code is new,
see on last page.



Rectangular displacement outlet Q-R....

Preliminary remarks

The rectangular displacement outlet is installed free standing on the floor, in front of a wall, parapet or pillar or built into the room furniture. Several displacement outlets can be placed adjacent to each other. The following criteria must be accounted for in the layout:

- Distance between outlet and workplace or seating (near zone)
- Air outlet volume flow rate
- Discharge velocity
- Possible size
- Temperature difference between supply air and indoor air

Our publication DS 4069 gives a general description of displacement ventilation with the calculation method for temperature gradients and cooling capacity. It also explains layout specifications for the near zone depending on outlet placement.

The discharge velocity should always keep below 0.25 m/s (see charts on pages 4 to 6). The requisite near zone and the displacement outlet dimensions must be accounted for.

Construction design and function

The main components of the rectangular displacement outlet are the housing 1, the perforated metal sheet 2 and the rectangular connection spigot 3. Circular connection spigots are available for outlets with greater depth - see table on page 3.

On request, the rectangular displacement outlet can be fitted with a strap 4 for wall fastening.

Air is distributed through a built-in guidance device that directs the discharged supply air jets at a slight upward incline and stabilizes them. This largely prevents a fast cold air drop and the attendant rise in air velocity near the air outlet.

The metal sheet generates a low-turbulence, low-momentum displacement flow to ensure the typical displacement ventilation jet pattern. The supply air spreads at about 10 to 30 cm above the floor at very low velocity.

The connection spigot can be positioned above or below; lateral connection on request.

The external dimensions are presented in the table on page 3 for the standard sizes. Other dimensions on request.

Sound power level and pressure loss

Sound power level and pressure loss are largely determined by the volume flow rate and air velocity resp. in

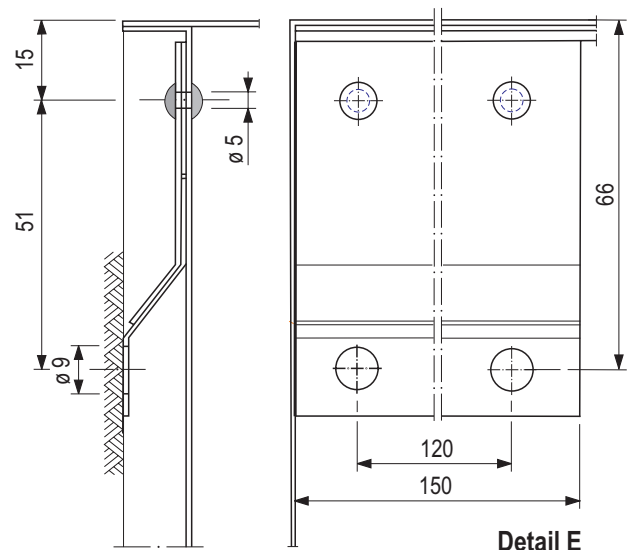
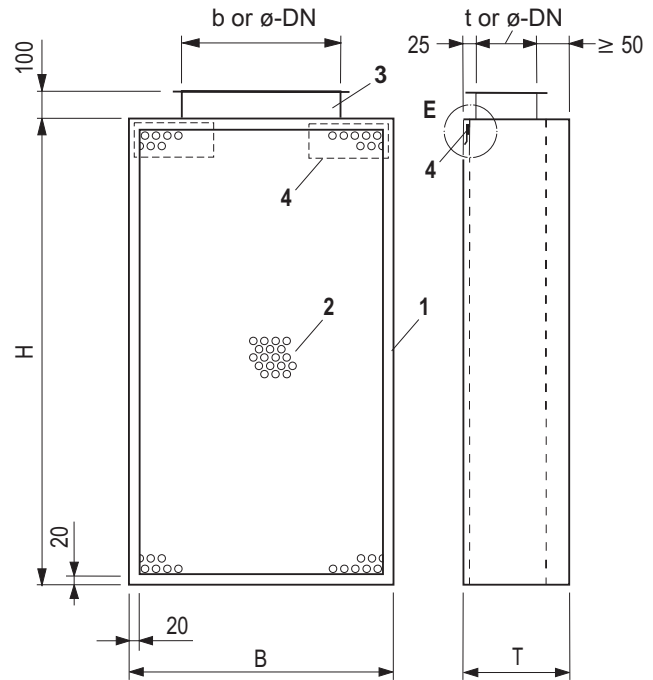

Rectangular displacement outlet,
above: Main dimensions,
below: Dimensions of the fastening strap.

the connection spigot and the discharge velocity at the perforated front plate.

The percental open area of the perforated metal sheet is the same for all rectangular displacement outlets. The connection spigot for a certain size can vary to meet different acoustic requirements.

The charts on pages 4 to 6 show sound power level and pressure loss for various connection spigot dimensions and air volume flow rates. Other connection spigot dimensions on request.

Rectangular displacement outlet

Dimensions ¹⁾ and weights

Height H mm	Width B in mm																	
	500						880						1380					
	Depth T mm	Spigot b t mm mm		Weight G ca. kg		Depth T mm	Spigot b t mm mm		Weight G ca. kg		Depth T mm	Spigot b t mm mm		Weight G ca. kg				
150	150	150	50		0.0075	3.5	150	300	50		0.015	6	150	300	50		0.015	8.5
	150	200	50		0.0100		150	400	50		0.020		150	400	50		0.020	
	150	250	50		0.0125		150	500	50		0.025		150	500	50		0.025	
	200	150	100		0.0150	4	200	300	100		0.030	6.5	200	300	100		0.030	10
300	150	200	50		0.010	5.5	150	300	50		0.015	9	150	400	50		0.020	13.5
	150	300	50		0.015		150	400	50		0.020		150	600	50		0.030	
	150	400	50		0.020		150	500	50		0.025		200	400	100		0.040	
	200	250	100		0.025	6	200	300	100		0.030	10	200	500	100		0.050	15
500	200	150	100		0.015	9	200	250	100		0.025	14.5	200	250	100		0.025	21.5
	200	200	100		0.020		200	300	100		0.030		200	500	100		0.050	
	200	250	100		0.025		200	400	100		0.040		200	750	100		0.075	22
	200	300	100		0.030		200	500	100		0.050		200	1000	100		0.100	
	300			180	0.025	10.5	300			180	0.025	16	300			200	0.031	24
	300			200	0.031		300			200	0.031		300			2x200	0.062	24.5
880	200	200	100		0.020	14.5	200	400	100		0.040	23	200	500	100		0.050	34
	200	300	100		0.030		200	500	100		0.050		200	750	100		0.075	
	200	400	100		0.040		300	300	200		0.060		300	500	200		0.100	37.5
	300	250	200		0.050	16.5	300	350	200		0.070	25.5	300	625	200		0.125	
	300	300	200		0.060		300	400	200		0.080		300	750	200		0.150	
	300			200	0.031		300	500	200		0.100		300	1000	200		0.200	
	350			250	0.049	17.5	350			250	0.049	26.5	350			250	0.049	38.5
	400			315	0.078	18.5	400			315	0.078	28	400			315	0.078	40.5
1380	200	400	100		0.040	21	200	500	100		0.050	34	200	1000	100		0.100	50.5
	300	300	200		0.060	24	200	750	100		0.075		300	750	200		0.150	55
	300	400	200		0.080		300	500	200		0.100	37.5	300	1000	200		0.200	
	400	400	250		0.100	27.5	300	625	200		0.125		400	825	300		0.248	59.5
	400	400	300		0.120		300	750	200		0.150	400	1000	300		0.300		
	400			225	0.040	27	400			225	0.040	40.5	400			225	0.040	58
	400			250	0.049		400			250	0.049		400			250	0.049	
	400			315	0.078		400			315	0.078		400			315	0.078	

1) Other dimensions on request

2) The external diameter of the connection spigot is 1 mm smaller than \varnothing -DN

3) A_{St} = cross-section of connection spigot

Rectangular displacement outlet ¹⁾

Sound power level and pressure loss

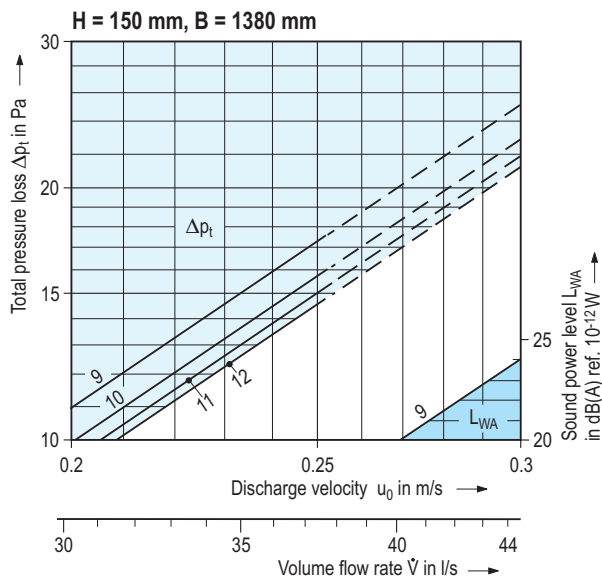
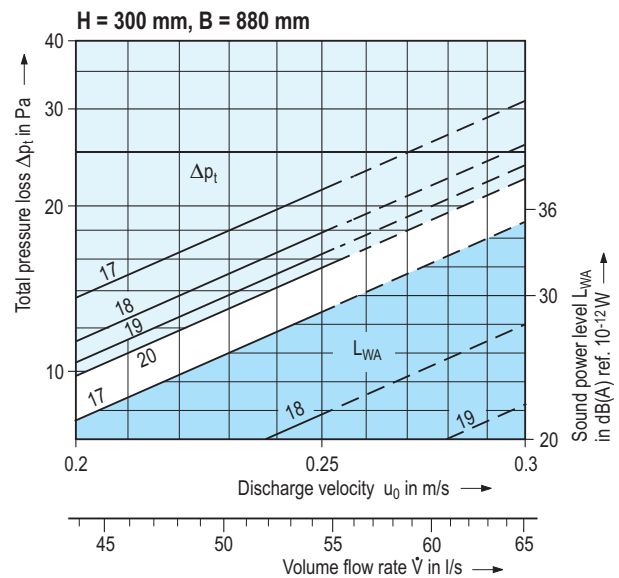
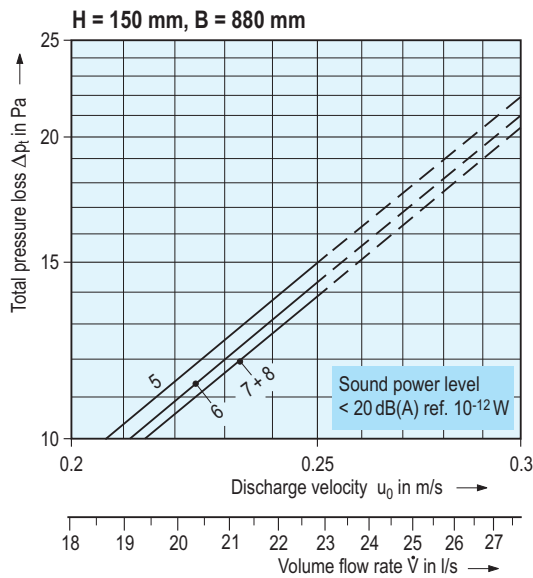
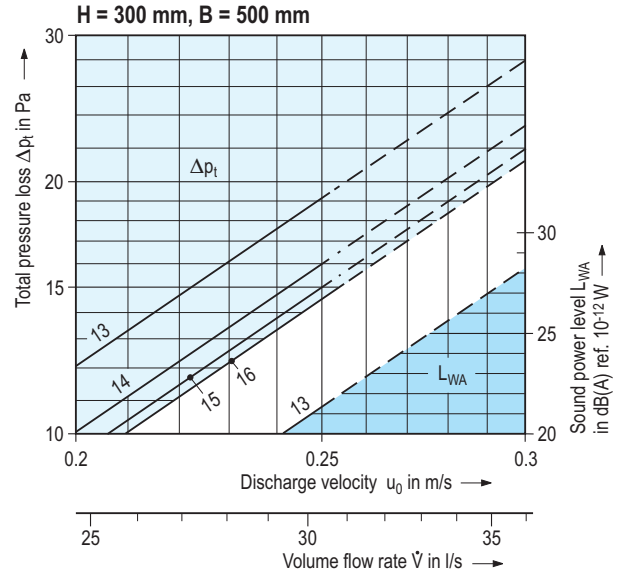
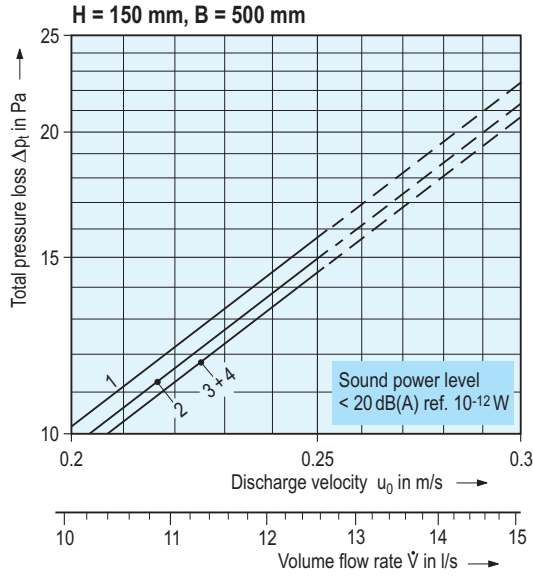

Nr.	T mm	b mm	t mm
1*	150	150	50
2*	150	200	50
3*	150	250	50
4*	200	150	100
5*	150	300	50
6*	150	400	50
7*	150	500	50
8*	200	300	100
9	150	300	50
10*	150	400	50
11*	150	500	50
12*	200	300	100
13	150	200	50
14*	150	300	50
15*	150	400	50
16*	200	250	100

Nr.	T mm	b mm	t mm
17	150	300	50
18	150	400	50
19	150	500	50
20*	200	300	100

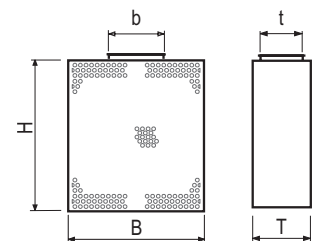

* Sound power level ≤ 20 dB(A) ref. 10^{-12} W

¹⁾ the discharge velocity [in the charts related to $(B - 40) \times (H - 40)$] must always be under 0.25 m/s

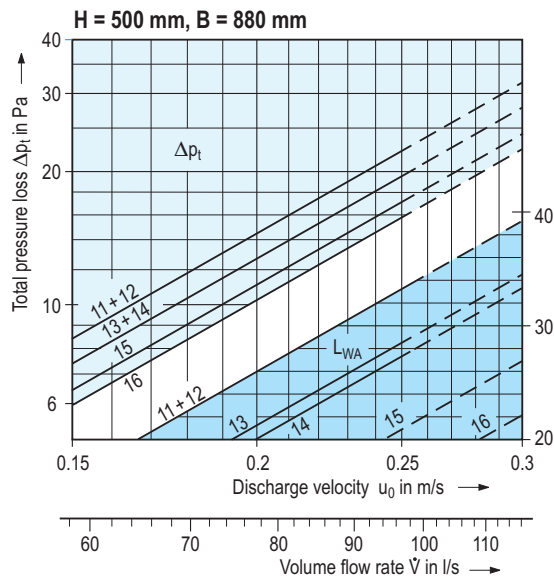
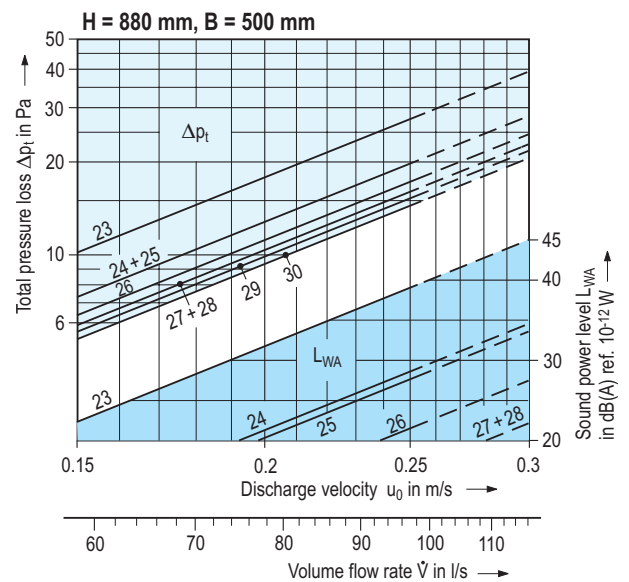
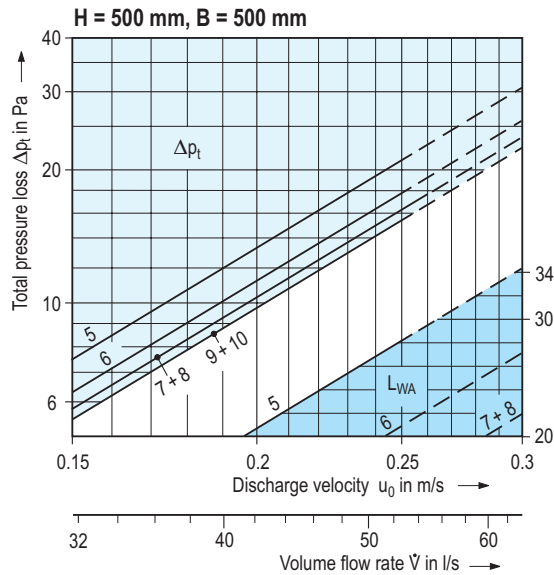
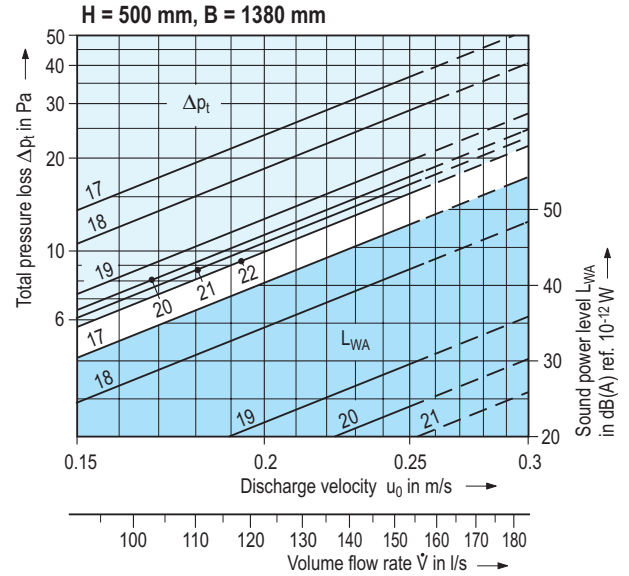
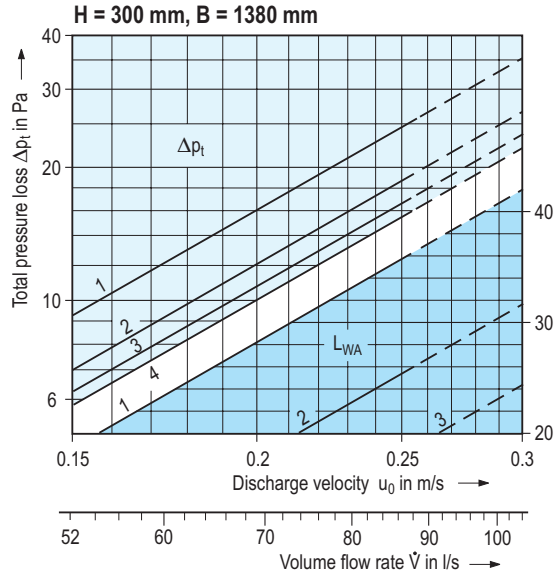

Nr.	T mm	b mm	t mm	ø-DN mm
1	150	400	50	—
2	150	600	50	—
3	200	400	100	—
4*	200	500	100	—
5	200	150	100	—
6	200	200	100	—
7	200	250	100	—
8	300	—	—	180
9*	200	300	100	—
10*	300	—	—	200
11	200	250	100	—
12	300	—	—	180
13	200	300	100	—
14	300	—	—	200
15	200	400	100	—
16	200	500	100	—
17	200	250	100	—
18	300	—	—	200
19	200	500	100	—
20	300	—	—	2x 200
21	200	750	100	—
22*	200	1000	100	—

Nr.	T mm	b mm	t mm	ø-DN mm
23	200	200	100	—
24	200	300	100	—
25	300	—	—	200
26	200	400	100	—
27	350	—	—	250
28	300	250	200	—
29*	300	300	200	—
30*	400	—	—	315

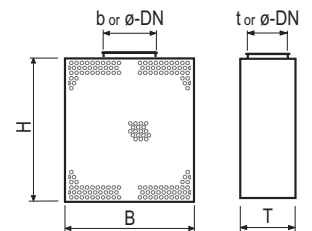

* Sound power level ≤ 20 dB(A) ref. 10^{-12} W

1) the discharge velocity [in the charts related to $(B - 40) \times (H - 40)$] must always be under 0.25 m/s

Rectangular displacement outlet ¹⁾

Sound power level and pressure loss

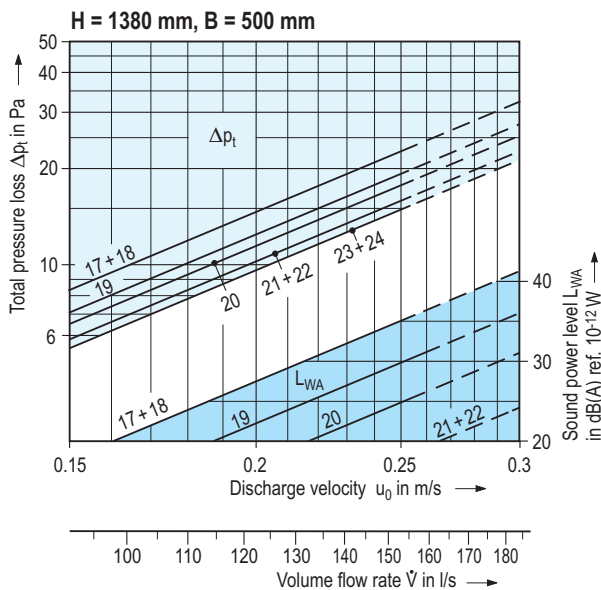
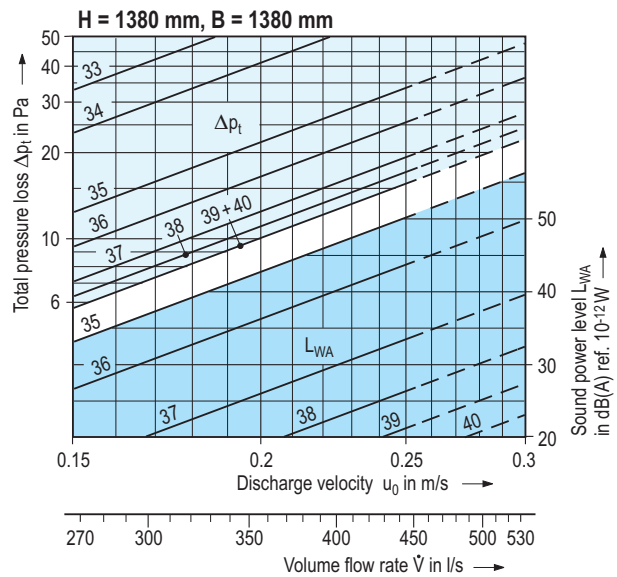
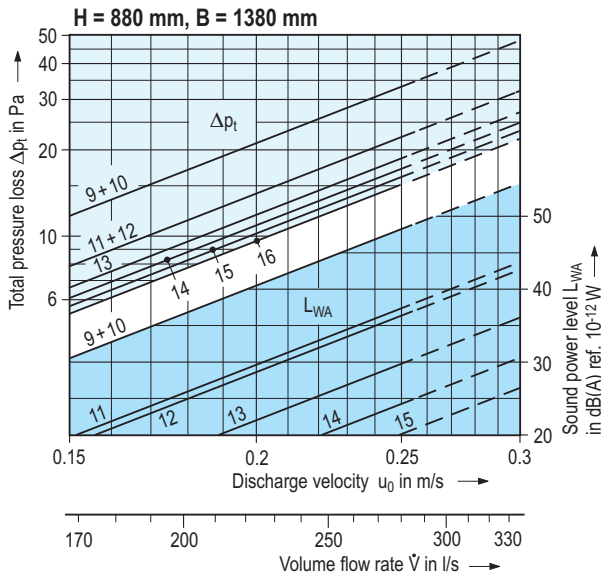
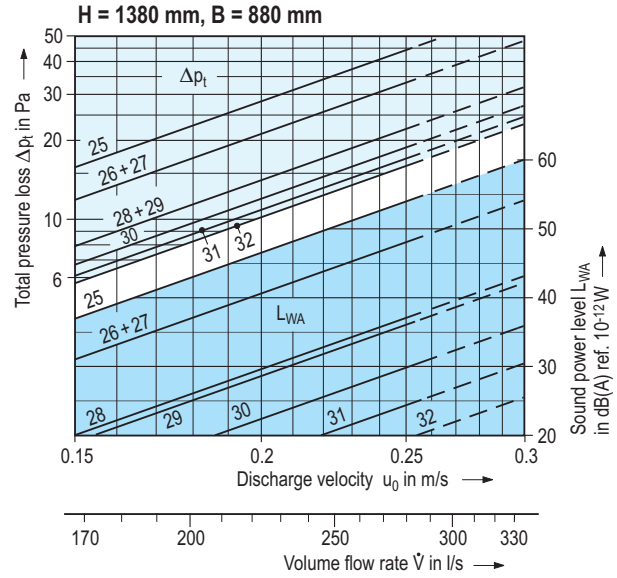
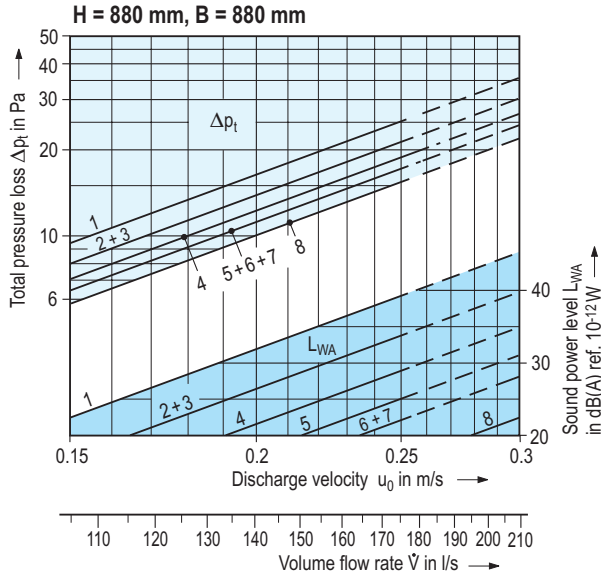

Nr.	T mm	b mm	t mm	ø-DN mm
1	200	400	100	—
2	350	—	—	250
3	200	500	100	—
4	300	300	200	—
5	300	350	200	—
6	400	—	—	315
7	300	400	200	—
8	300	500	200	—
9	350	—	—	250
10	200	500	100	—
11	200	750	100	—
12	400	—	—	315
13	300	500	200	—
14	300	625	200	—
15	300	750	200	—
16*	300	1000	200	—
17	400	—	—	225
18	200	400	100	—
19	400	—	—	250
20	300	300	200	—
21	400	—	—	315
22	300	400	200	—
23*	400	400	250	—
24*	400	400	300	—

Nr.	T mm	b mm	t mm	ø-DN mm
25	400	—	—	225
26	400	—	—	250
27	200	500	100	—
28	200	750	100	—
29	400	—	—	315
30	300	500	200	—
31	300	625	200	—
32	300	750	200	—
33*	400	—	—	225
34*	400	—	—	250
35	400	—	—	315
36	200	1000	100	—
37	300	750	200	—
38	300	1000	200	—
39	400	825	300	—
40	400	1000	300	—

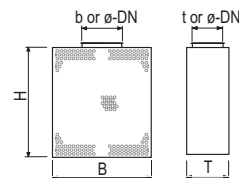

1) the discharge velocity [in the charts related to $(B - 40) \times (H - 40)$] must always be under 0.25 m/s

* Sound power level ≤ 20 dB(A) ref. $10^{-12} W$



Rectangular displacement outlet end face at a wall, air supply from above via circular connection spigot

Features

- Even, low-turbulence and draught-free discharge flow with small near zone at the outlet
- Large coverage (5 to 15 m)
- Low sound power level
- Temperature difference between supply air and indoor air usually -2 to -3 K and between supply air and exhaust air up to about -12 K, depending on room height and volume flow rate
- Single installation or in close sequence
- Connection spigot in various sizes depending on acoustic requirements above or below
- Visually attractive design
- Made of sheet metal, painted in desired colour
- Available in many sizes
- Maintenance-free

Type code

Q - R - ___ / ___ / ___

Displacement outlet -----

Rectangular -----

Size -----

Please note,
type code is new,
see last page.

Size

Width / height / depth

Tender text

..... units

Rectangular displacement outlet to generate extremely low-turbulence, displacement flow and large penetration depth in commercial rooms,

Air distribution via integrated guidance device,

Placement on the floor,

in front of a wall, parapet or pillar,

built into room furniture,

freestanding in room,

made up of:

slim rectangular housing,

perforated metal front sheet,

rectangular connection spigot to fit standard ducts,
 with corner flanges,

circular connection spigot to fit DIN 24 145 pipes (folded spiral-seam tube) or DIN 24 146 (flexible tubes),

Position of connection spigot above. below.

strap for fastening back to wall.

Technical Data:

Supply air volume flow rate: l/s

Adm. sound power level: dB(A)
ref. 10⁻¹² W

Material: galvanized steel

Quality paint, colour to: RAL

Dimensions

Width: mm

Height: mm

Depth: mm

Rectangular connection spigot

Width: mm

Depth: mm

Circular connection spigot

Nominal-ø: DN

Make: KRANTZ KOMponenten

Type: Q - R - ___ / ___ / ___



YIT Germany GmbH
KRANTZ KOMPONENTEN
Uersfeld 24 | D-52072 Aachen | Germany
Phone: +49 241 441-1 | Fax: +49 241 441-555
info@krantz.de | www.krantz.de

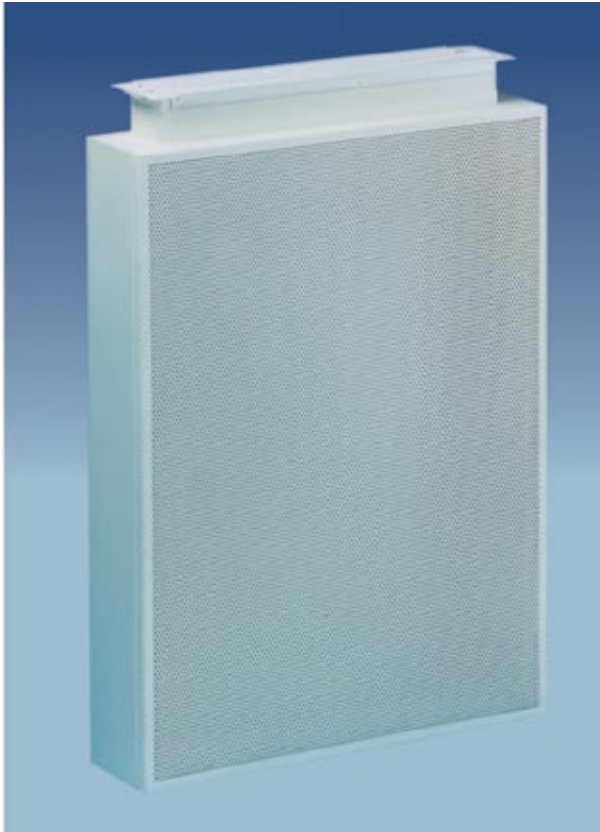

Rectangular displacement outlet

Type code

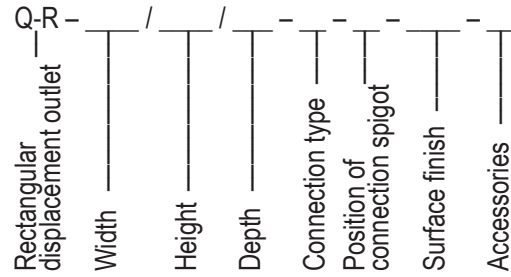

Width

- 500 = Width 500 mm
- 880 = Width 880 mm
- 1000 = Width 1000 mm
- 1380 = Width 1380 mm

Height

- 150 = Height 150 mm
- 300 = Height 300 mm
- 500 = Height 500 mm
- 880 = Height 880 mm
- 1000 = Height 1000 mm
- 1380 = Height 1380 mm

Depth

- 150 = Depth 150 mm
- 200 = Depth 200 mm
- 300 = Depth 300 mm

Connection type

- S = Rectangular spigot, smooth
- Z = Rectangular spigot with corner flange

Position of connection spigot

- O = Connection spigot on top
- U = Connection spigot at bottom

Surface finish

- 9010 = Face painted to RAL9010, semi-matt
- = Face painted to RAL

Accessories

- O = none
- Z = Fasteners for wall mounting

Subject to technical alteration.